

USER'S GUIDE

Version 1.0



EMD sensor Network 10/100

Reset

220.8

1.16A 1P PDU sequence:
V->A->KWxh
2.32A 1P PDU sequence:
V->
Circuit Breaker 1
(br1->A)->
Circuit Breaker 2
(br2->A)->
TOTAL
(TOTL->A->KWxh)

PIML

Table of Content

Preface	3
About this Manual	3
Copyright Information	3
Safety Instructions	4
Safety Notices	5
Introduction the POWERTEK	6
Features	7
Package Contents	8
Hardware Components	9
Status 7 segments display	9
Getting Started	10
Rack Mounting	10
Making Connections	11
Connecting Input Power	12
Connecting Output Devices	13
Connecting EMD	14
Connecting to a LAN/WAN	15
Using the (RCM) Residual Current Monitoring	16
Using the Console Menu	17
Navigating through the Console Menu	17
Using the Web Interface.	19
Summary Overview-System Overview	19
Summary Overview-Alarm List	20
Summary Overview-Network Connection	20
Power Management-Inlet Configuration	21

Table of Content

Power Management-Environment Monitoring	22
Network-TCP/IP	23
Network Management-Accessible IP Setting	23
Network Management-Security	24
Network Management-Network Service	24
Network Management-SNMP Setting	25
Network Management-SNMP Trap Setting	25
Settings-General Setting	26
User management	26
Settings-Maintenance	27
Settings-Import/Export	27
Settings-Radius User	28
Settings-Local User	29
Log and Notification-System Log	30
Log and Notification-Event Log	30
Settings-Configure SMTP Server	31
Settings-Email Notification Setting	31
Log and Notification-Inlet History Log	32
Log and Notification-Environment History Log	32

Preface

About this Manual

Congratulations on purchasing a POWERTEK PDU. This user manual provides detailed descriptions of the hardware components and how to use the product. Read this manual carefully and follow the instructions before installing.

Copyright Information

No part of this manual, including the products and software described in it, may be reproduced, transmitted, transcribed, stored in a retrieval system, or translated into any language in any form or by any means, except documentation kept by the purchasers for backup purposes, without the express written permission of the manufacturer.

Products and corporate names appearing in this manual may or may not be registered trademarks or copyrights of their respective companies, and are used only for identification or explanation and to the owners' benefit, without intent to infringe. All trademarks are the property of their respective owners.

Preface

Safety Instructions

Follow these safety instructions to avoid injury to yourself and damage to the POWERTEK PDU.

- To reduce the risk of fire or electric shock, install the unit in a temperature-controlled indoor area free of conductive contaminants. Do not place the unit near liquids or in an excessively humid environment.
- Do not allow liquids or foreign objects to enter the unit.
- The unit does not contain any user-serviceable parts.
- Do not open the unit.
- Servicing, maintenance, and repair for this equipment must be performed by qualified service personnel. Remove rings, watches and other jewelry before servicing the unit.
- Before maintenance, repair or shipment, the unit must be completely switched off and unplugged and all connections must be removed.
- Before plugging in the power cord of the device, make sure that the power source rating matches the power rated indicated on the product labels.
- Use a harmonized and certified power cord when connecting any device to the outlets.
- The digital output can only connect switches, indicators, or other output devices that are normally open or normally closed.

Preface

Safety Notices



Caution:

This unit has been provided with a real time clock circuit. There is a danger of explosion if the battery is incorrectly replaced. Replace only with a 3V Lithium cell (CR1220) or equivalent type. Discard used batteries according to the manufacturer's instructions.



Caution:

Rack-Mounted Equipment – The unit is intended to be rack-mounted, the Installation Instructions shall contain wording to address the following concerns when the unit is mounted in a rack system.

“The equipment is to be installed in an environment with maximum ambient temperature must not exceed 60°C.”

“The openings on the enclosure are for air convection hence protected the equipment from overheating. **DO NOT COVER THE OPENINGS.**”

“Lay this equipment on a reliable surface when installing. A drop or fall could cause injury.”

“The equipment shall be installed according to specification as nameplate. Make sure the voltage of the power source when connecting the equipment to the power outlet. The current of load and output power of loads should not be over the specification.”

“This equipment must be connected to the reliable earth before using.”

Introduction the POWERTEK

The POWERTEK PIML PDU, is an intelligent power strip designed to power monitor the input and circuit breaker consumption and auto email history report to supervisor for power bill charge. At the same time, provides the useful ability of managing power for any combination of network equipment connected to it. Users can control the power on/off for any device connected to the PDU remotely, using a console or Ethernet connections.

It's also equipped with a console port for connecting upto 8 EMD (Environmental Monitoring Device) in cascade for sensing temperature and humidity along with two alarms that can be activated when either of the sensors shows unusual values.

Introduction the POWERTEK

Features

- To calculate the power consumption on an hourly basis, and to have an accumulation daily
- Provides detailed data-logging for statistical analysis and diagnostic then auto email daily history report
- Event notification by pop-up/Sending Trap or E-Mail for events notifications.
- Set overcurrent watchdog for each outlet (Threshold settings for over-current warnings and alerts)
- Versatile sensors supported through EMD (Environmental Monitoring Device) inputs
- Comprehensive power management and flexible configuration through web browser, NMS, Telnet, SNMP V1,2,3 ,
- Support Secure Socket Layer V3 and Secure Shell V2 protocols
- Administrator and multiple users with password protection for double-layer security
- Address-specific IP security masks to prevent unauthorized access
- User-friendly interface to display input and output status
- Upgrade utility for easy firmware upgrade

Introduction the POWERTEK

Package Contents

Make sure the POWERTEK PDU package has the following items. If any of the items are missing or damaged, contact your nearest service center or vendor.

1. POWERTEK PDU
2. Toolless Mounting Brackets (x2)
3. Mounting brackets (x2)
4. Button mount (x2)
5. Button Mount bracket (x2)
6. Screws (x8)
7. Quick Install Guide

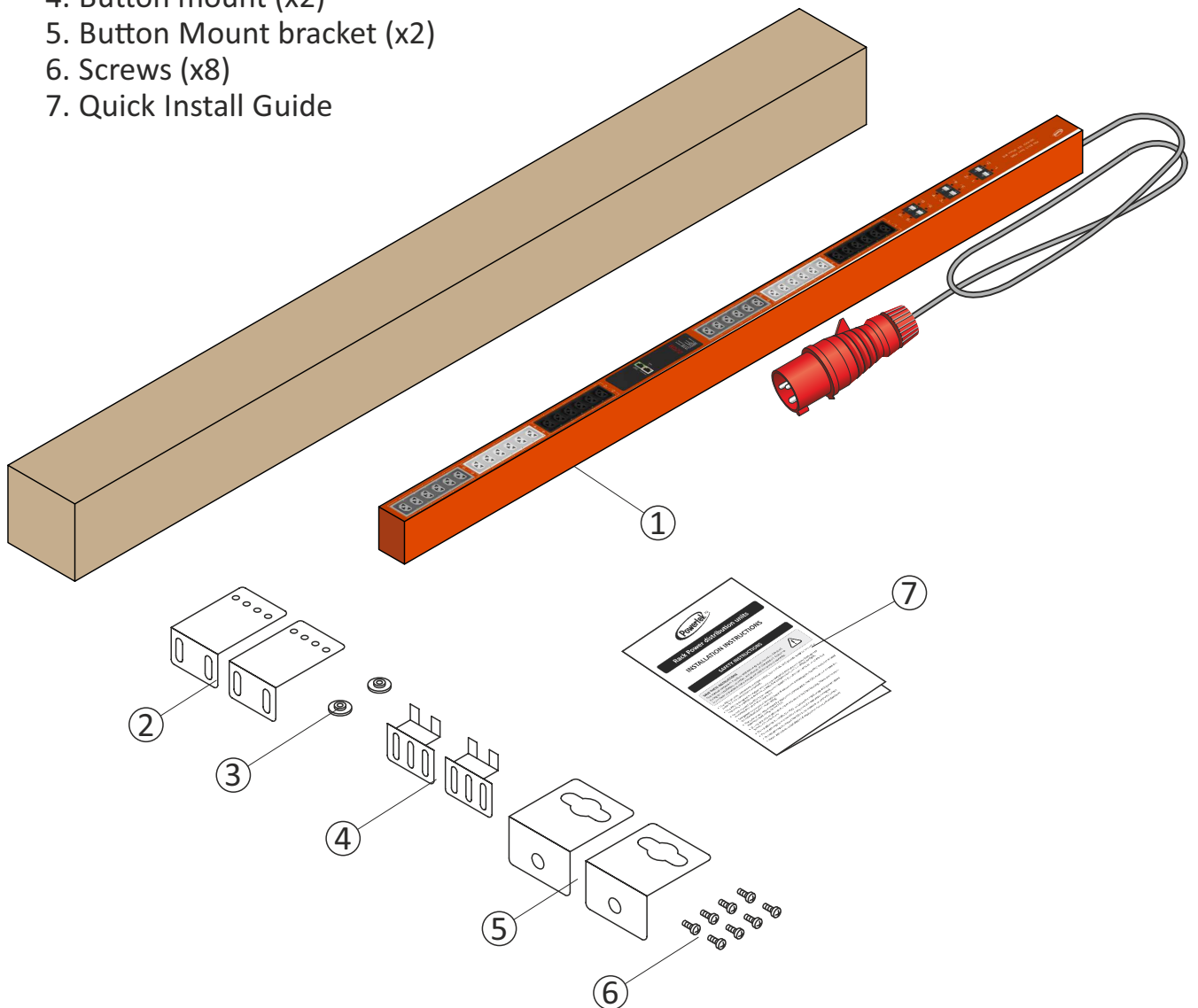

Introduction the POWERTEK

Hardware Components

The following sections provide descriptions about the front panel components and how to use them.

	Component	Description
1.	Inlet	Power lead to be connected to the Data Centre power source
2.	Breaker	Prevent excessive current flow to protect the system
3.	Status 7 segments	Display input Power Data
4.	Mounting Options	Different choice of mounting options

Status 7 segments display

The front panel of the POWERTEK PDU has an 7 segments display that provides information about the input power status.

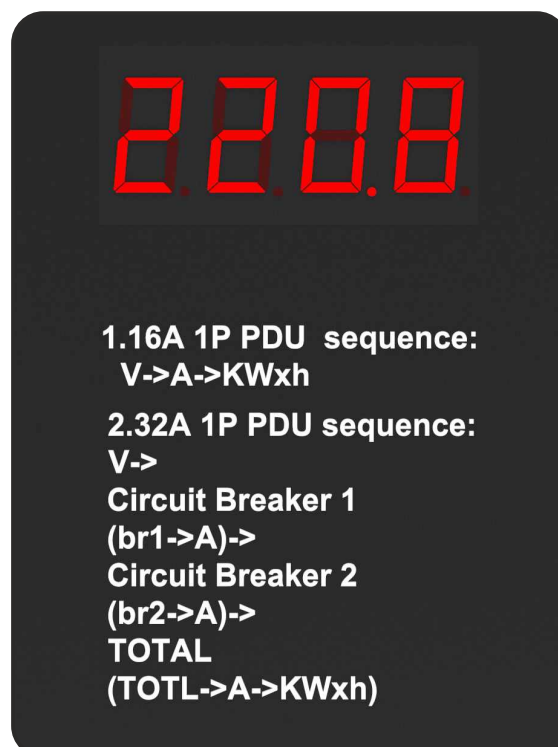

Getting Started

This section provides information about setting up the POWERTEK PDU, connecting power, and connecting devices to it before users start using it for power management. Read this section carefully to learn how to connect various devices to the POWERTEK PDU.

Rack Mounting

The POWERTEK PDU can be installed in most standard racks. After attaching the desired mounting, position the device in the rack and line the holes of the (mounting brackets) with the hole on the rack.

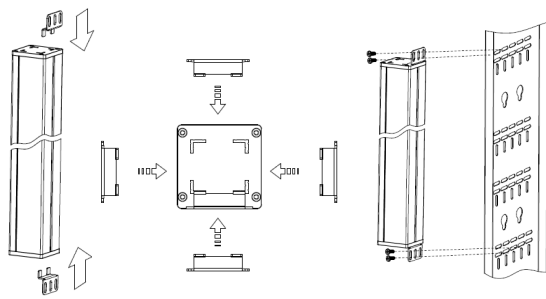

Option 1: Insert the toolless mounting brackets into the ends of the PDU (note the brackets can face all four sides of the PDU; be sure to insert them so that the outlets face the desired direction), then mount PDU to rack rails using user supplied mounting hardware.

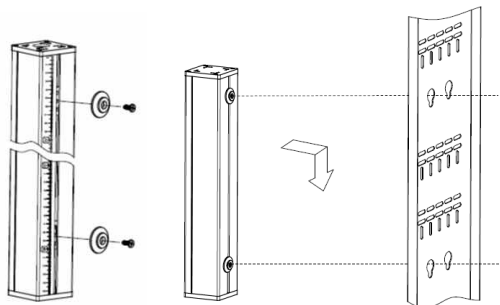

Option 2: Fix the button mounts on your desired position (note the nuts to fix the button can move along the PDU), then mount the PDU into the button mount holes of your rack.

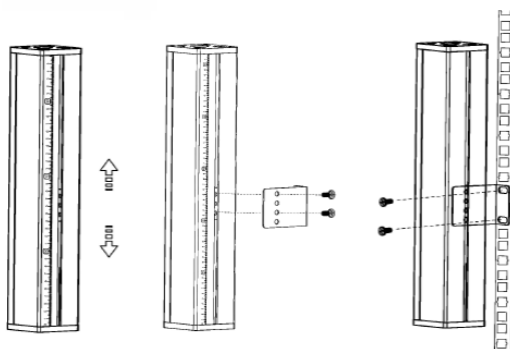

Option 3: Screw the brackets on your desired position (note the nuts to fix the button can move along the PDU), then mount PDU to the rack rails using the user supplied mounting hardware.

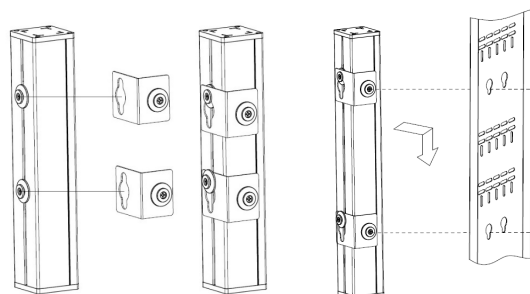

Option 4: Fix the button mounts on to your desired position (note the nuts to fix the button can move along the PDU), then mount the bracket into the button mount holes of your rack.

Getting Started

Making Connections

The POWERTEK PDU is a versatile product that can be connected to several different types of input and output devices. This makes it a useful tool for connecting devices to it and to monitor the power through its user interface.

It also supports an EMD (Environmental Monitoring Device) connecting with sensors for detecting environmental conditions as well as digital outputs for enabling devices with normally open or closed conditions. More over, it supports Ethernet (LAN/WAN) connection that lets users control the PDU outputs remotely.

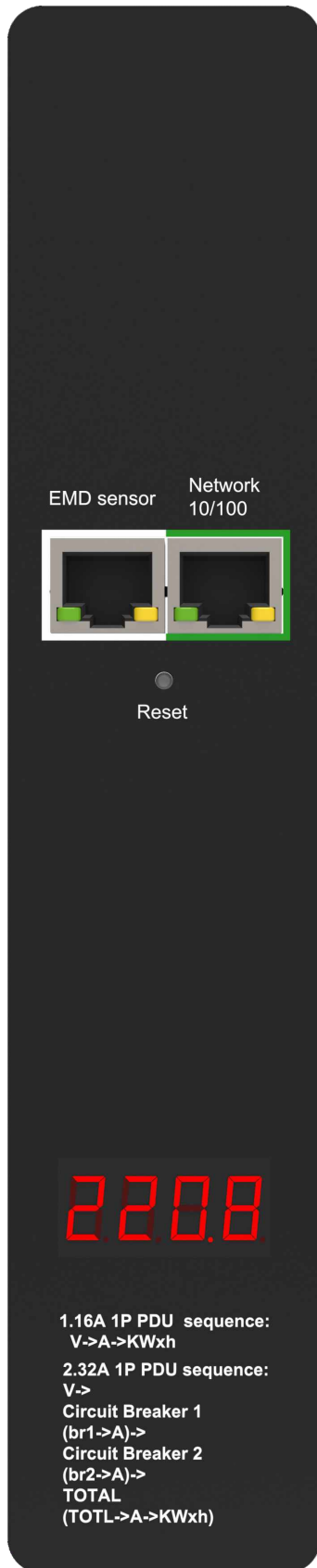

Getting Started

The following procedure describes the basic steps needed to set up the POWERTEK PDU:

1. To set up the hardware, connect the power input and output devices to the power outlets.
2. To configure the Power Strip, users must use the LAN port. Connect the device to the LAN to enable its configuration through the browser menu.
3. After connecting it to a console, use a console application such as Telnet or HyperTerminal to access the console menu. Select the TCP/IP submenu under the Network Management to set up the IP address and select the General Setting submenu under the System Management to set up the system date/time. This IP address will be used while accessing the web interface to configure the POWERTEK PDU parameters.
4. After connecting to LAN, open a browser from a PC in the network and use the POWERTEK's IP address specified through the console menu to open the web interface for system configuration.

The following sections provide instructions on how to make various connections.

Connecting Input Power

The POWERTEK PDU has different power inlets according to the voltage, current and phase required in each country.

Getting Started

Connecting Output Devices

The Power strips can have a different number of outlets for connecting devices such as workstations, servers, and printers. Connect the power connectors of the devices to each of the power outlets.

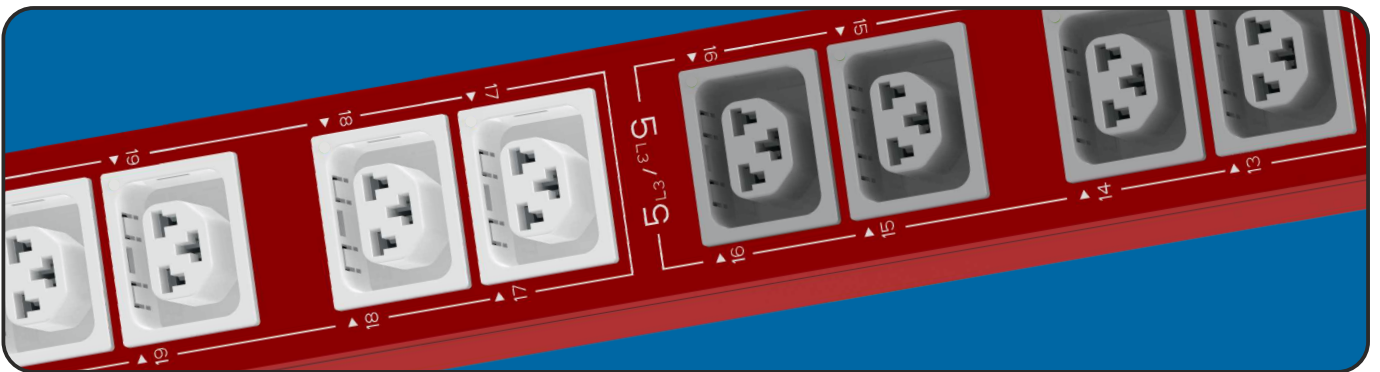

The POWERTEK PDUs are available in the following sockets:

220V/16A: IEC C13/C19 combo

220V/10A IEC C13, IEC C13 (Lock), AS/NZS 3112

220V/16A SEV T13, SEV T23, CEE7, IEC C19, IEC C19 (lock), SEV T23

220V/13A: UK BS1363

220V/15A: AS/NZS 3112

120V/15A: NEMA 5-15P

120V/20A: NEMA5-20P

Getting Started

Connecting EMD

An Environmental Monitoring Device (EMD) that is connected to sensors for detecting temperature, humidity, and two digital inputs can be connected to the POWERTEK PDU with the console port. The EMD can also be connected to alarms or indicators and controlled through the web browser. Up to 8 EMD can be connected in cascade to monitor the temperature and humidity in different parts of the racks.

1. Connect the EMD to the console port as shown:

After connecting the EMD, open a web browser from a PC and enable environmental sensors on the web user interface, then the temperature and humidity status is automatically displayed on the System Overview page.

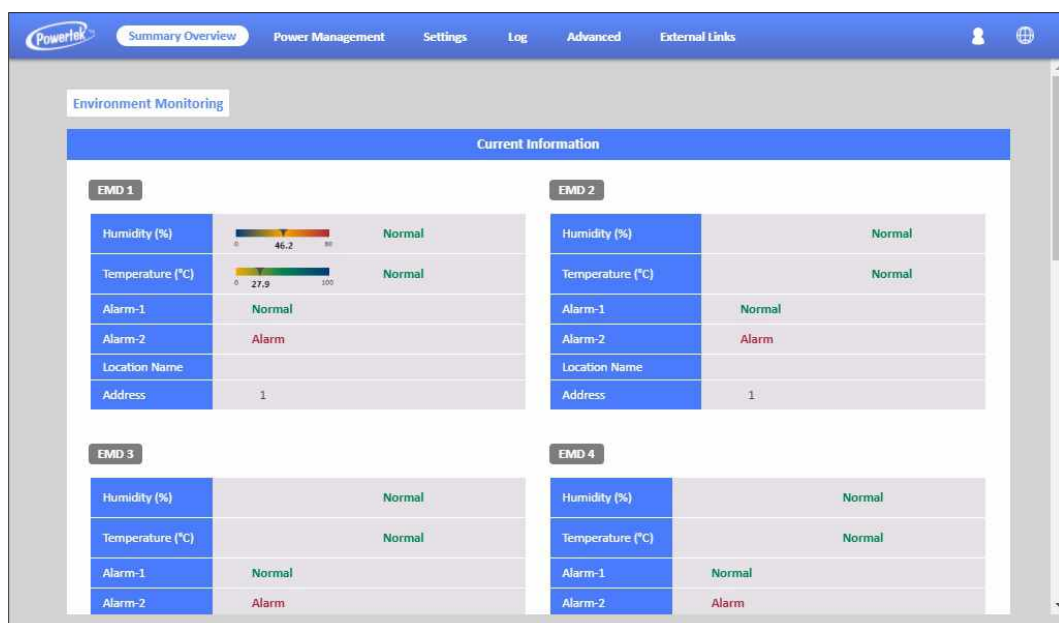

Getting Started

Connecting the digital input sensors

On each EMD sensor you can connect 2 digital input sensors: (water leak, door contact, motion, vibration, smoke and any other sensor with normally open or closed).

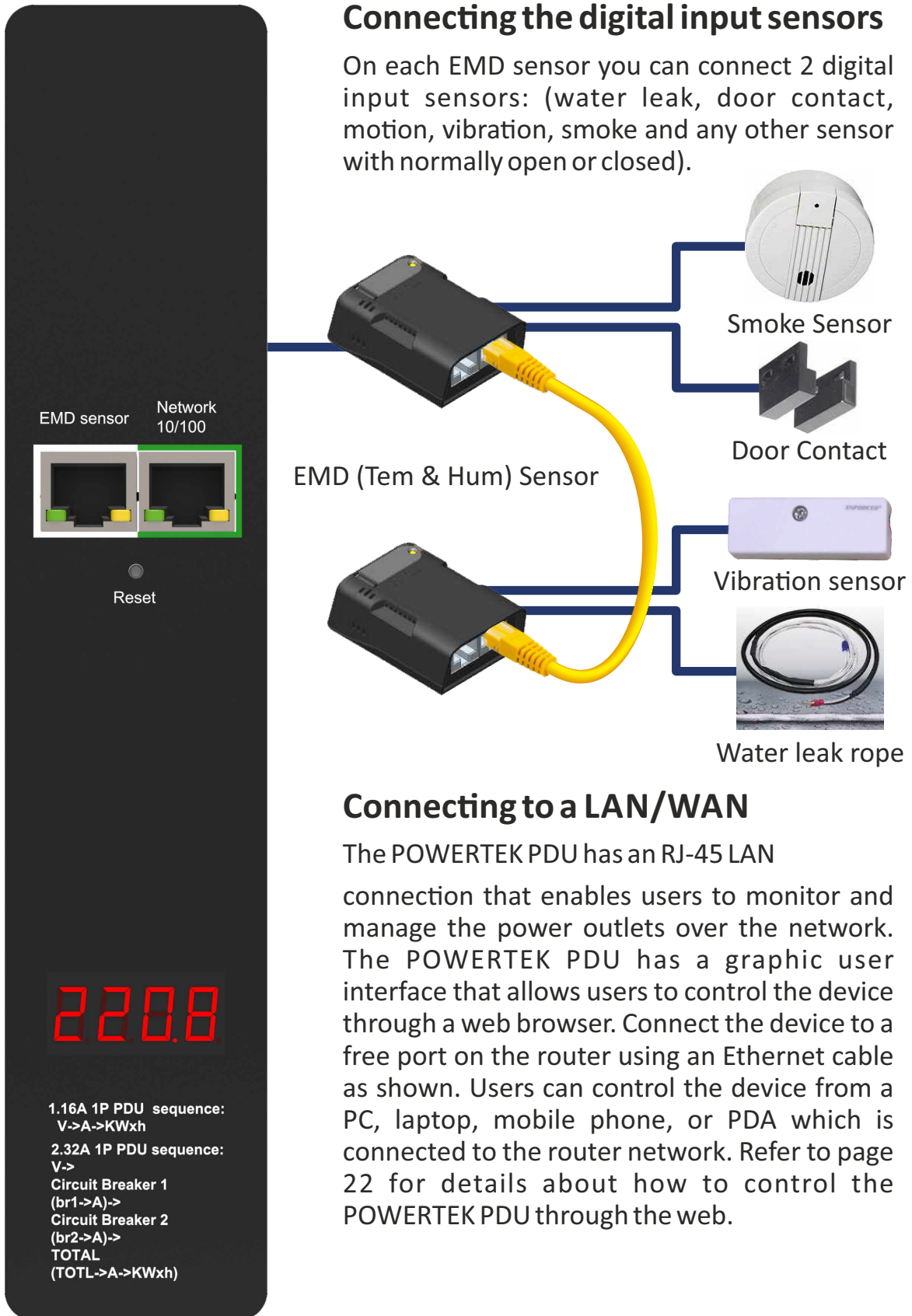

Connecting to a LAN/WAN

The POWERTEK PDU has an RJ-45 LAN connection that enables users to monitor and manage the power outlets over the network. The POWERTEK PDU has a graphic user interface that allows users to control the device through a web browser. Connect the device to a free port on the router using an Ethernet cable as shown. Users can control the device from a PC, laptop, mobile phone, or PDA which is connected to the router network. Refer to page 22 for details about how to control the POWERTEK PDU through the web.

Getting Started

Using the (RCM) Residual Current Monitoring:

When a residual current device is triggered, besides the LCM keep flashing will display the “WARNING” signal as shown.



Users can set the related setting of residual current from the Inlet Configuration webpage as shown.

1. Alarm there holds a setting range for 3mA to 50mA, There holds default setting is 20mA, when residual current greater than or equal to threshold value, an alarm is triggered.
2. When DC residual current is greater than or equal to 5mA, an alarm is triggered.
3. When AC residual current is greater than or equal to 20mA, an alarm is triggered.
4. When the alarm threshold value setting is less than or equal to 5mA, If DC residual current or AC residual are active, an alarm is triggered.
5. When the alarm threshold value setting is less than or equal to 20mA, If AC residual current is active, an alarm is triggered and DC residual current will be ignored.

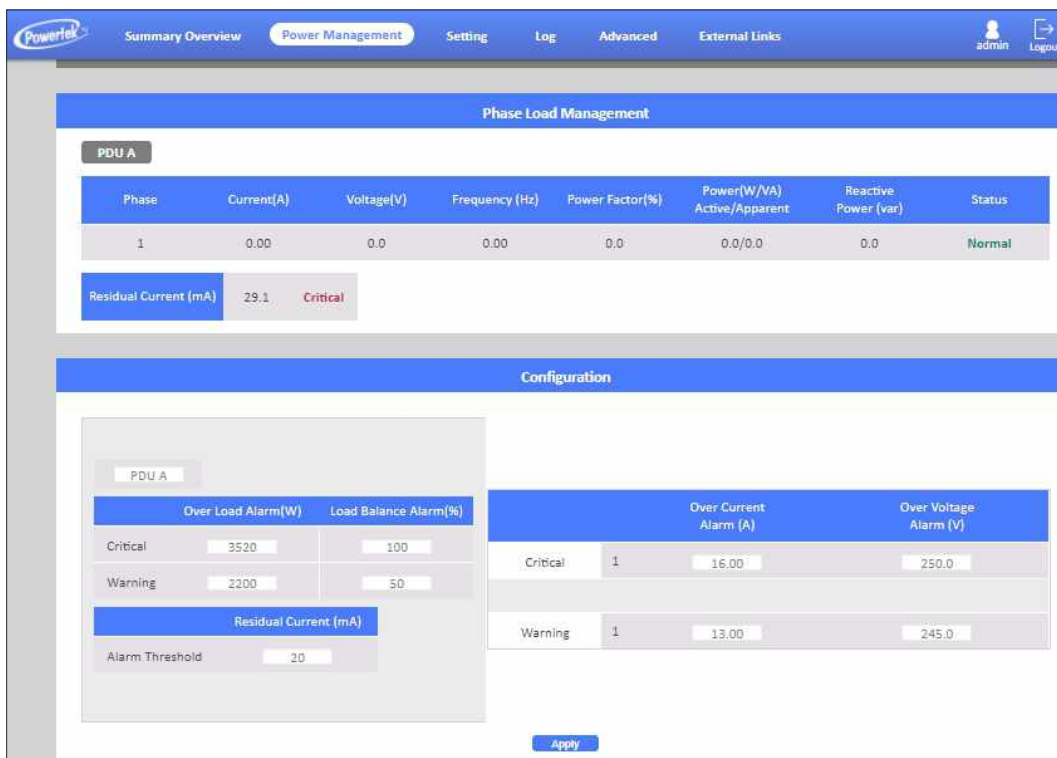

The screenshot displays the PowerTel web interface. The top navigation bar includes 'Summary Overview', 'Power Management', 'Setting', 'Log', 'Advanced', and 'External Links'. The user is logged in as 'admin'. The main content area is divided into two sections: 'Phase Load Management' and 'Configuration'.

Phase Load Management:

Phase	Current(A)	Voltage(V)	Frequency (Hz)	Power Factor(%)	Power(W/VA) Active/Apparent	Reactive Power (var)	Status
1	0.00	0.0	0.00	0.0	0.0/0.0	0.0	Normal

Below the table, the 'Residual Current (mA)' is shown as 29.1, which is in a 'Critical' state.

Configuration:

The configuration section is split into two panels. The left panel shows alarm thresholds for 'Over Load Alarm(W)' and 'Load Balance Alarm(%)' with 'Critical' and 'Warning' levels. The 'Residual Current (mA)' section shows an 'Alarm Threshold' of 20.

	Over Current Alarm (A)	Over Voltage Alarm (V)
Critical	16.00	250.0
Warning	13.00	245.0

An 'Apply' button is located at the bottom of the configuration section.

Using the Console Menu

Navigating through the Console Menu

Follow these steps to navigate through the console menu to modify the settings:

- To select a submenu, type the number corresponding to the submenu and press Enter. For example, to select the PDU Configuration Settings menu, type 1 and press Enter. Submenus may have further nested menus which can also be accessed by typing the appropriate number.
- To modify a menu option, select the option with its corresponding number and then type the new values for the option. For instance, to change the system date, first select the System Date option by typing 1 from the Day and Time Group and press Enter. Then type the date in the specified format (dd/mm/yyyy) and press Enter to save the changes.
- Type 0 (zero) to return to a previous or higher-level menu.

```
+-----+
|                                     |
|               PDU Configuration Utility               |
|               [PDU Configuration Settings]            |
|-----+-----+
Version   :      System v1.00 (2M)(SN)
Ethernet address : 00 E0 D8 00 7F 61
1. IP, Time and System Group
0. Back to Main Menu

Please Enter Your Choice =>
```

```
+-----+
|                                     |
|               PDU Configuration Utility               |
|               [IP, Time and System Group]            |
|-----+-----+
Firmware Version :      _v0.80_b01
Ethernet address  : 00:E0:D8:00:7F:61
1. IPv4 Group
2. IPv6 Group
3. Date and Time Group
4. System Contact : Technical Support Team
5. System Name : XXXXX
6. System Location : OOOOOOO
0. Back to Main Menu

Please Enter Your Choice =>
```

Using the Console Menu

The console menu consists of the following submenus:

- IPv4 Group:

Type 1 and press Enter, then input new IP address and press Enter. The IP Address has been updated.

Type 2 and press Enter, then input the new Gateway address and press Enter. The Gateway Address has been updated.

Type 3 and press Enter, then input new Network Subnet and press Enter. The Network Subnet has been updated.

```
+=====+
|           IP, Time and System Group           |
|                [IPv4 Group]                   |
+=====+
1. IP Address   : 10.1.2.170
2. Gateway Address : 10.1.1.254
3. Network Subnet : 255.255.0.0
0. Return to previous menu
```

- IPv6 Group:

Type 1 and press Enter, then input new IPv6 address and press Enter. The IPv 6 Address has been updated.

```
+=====+
|           IP, Time and System Group           |
|                [IPv6 Group]                   |
+=====+
1. IP v6 Address : 2001:b183:1:1:2e0:d8ff:feff:b585/64
0. Return to previous menu
```

- Date and Time Group:

Type 1 and press Enter, then input System Date and press Enter. The System Date has been updated.

Type 2 and press Enter, then input new System Time and press Enter. The System Time has been updated.

```
+=====+
|           IP, Time and System Group           |
|                [Date and Time Group]          |
+=====+
1. System Date (dd/mm/yyyy)   : 30/05/2014
2. System Time (hh:mm:ss)     : 15:05:17
3. NTP Control                 : Disabled
4. NTP Server                  :
5. Time Zone                   : 62
6. Daylight Saving Time Control : Disabled
0. Return to previous menu
```

Type 3 and press Enter, then input [1] for Enable / [0] for Disable “NTP” and press Enter. The NTP control setting has been updated.

Type 4 and press Enter, then input NTP Server and press Enter. The NTP Server has been updated.

Type 5 and press Enter, then input Time Zone and press Enter. The Time Zone has been updated.

Type 6 and press Enter, then input [1] for Enable / [0] for Disable “Daylight Saving Time” and press Enter. The “Daylight Saving Time” setting has been updated.

- System Contact: Input and click enter to update System Contact.
- System Name: Input and click enter to update System Name.
- System Location: Input and click enter to update System Location.

Using the Web Interface

The POWERTEK PDU provides a graphic user interface that can be viewed from a web browser such as Internet Explorer. This enables users to access and control the device outlets and subsequently, its output devices remotely from users' desktop, laptop, PDA, or even users' mobile phones. This section provides instructions about how to use the web interface to configure and control the PDU remotely.

Summary Overview-System Overview

Start a web browser such as Internet Explorer from the host PC or laptop and enter the IP address of the Power Strip in the address bar. For details about setting the IP address of the system. You will be prompted to enter a Username and Password. Click Go and the main status page of the POWERTEK PDU web interface is displayed.

The default settings are:

DHCP: Enabled

IP Address: 192.168.1.250

Subnet Mask: 255.255.255.0

Gateway: 192.168.1.10

Username: admin

Password: admin

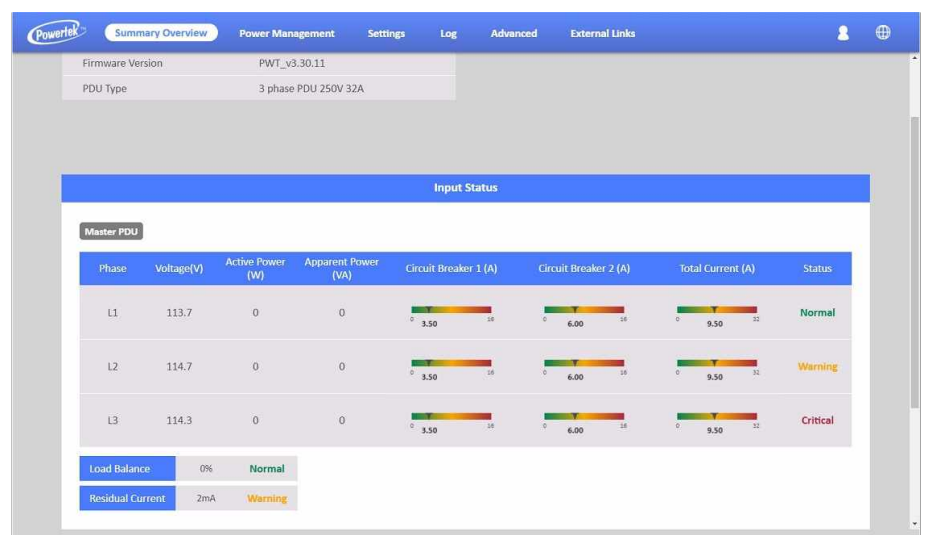

The main page shows a graphic representation of the Power Strip outlets and inputs status as described below:

- The panel shows the various menus and submenus. Click any menu to display the menu options, expand the menu items, and modify the menu options as required.
- The right panel shows the current status of the Power strip.

Using the Web Interface

Summary Overview-Alarm List

The “Alarm List” page shows the list of Alarms, which were set by the user. POWERTEK PDU will follow the rules of an alarm to send out notification to the user.

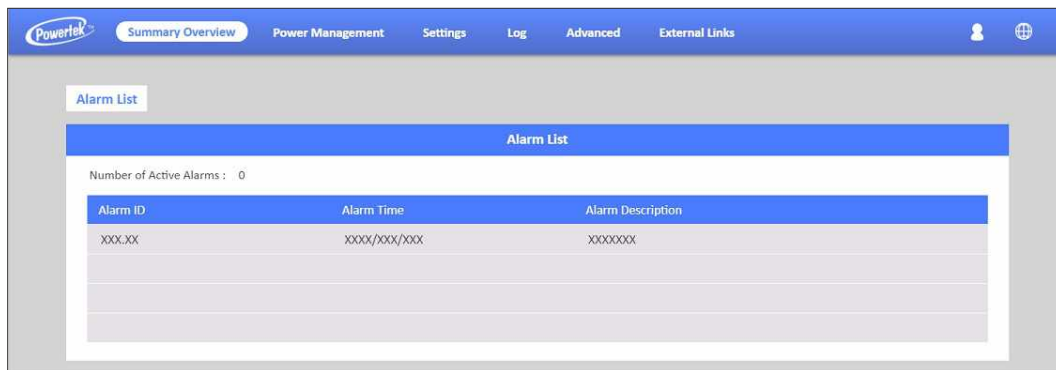

Alarm ID	Alarm Time	Alarm Description
XXX.XX	XXXX/XXX/XXX	XXXXXXXX

Summary Overview-Network Connection

The Network Connection page shows a list of user's connections.

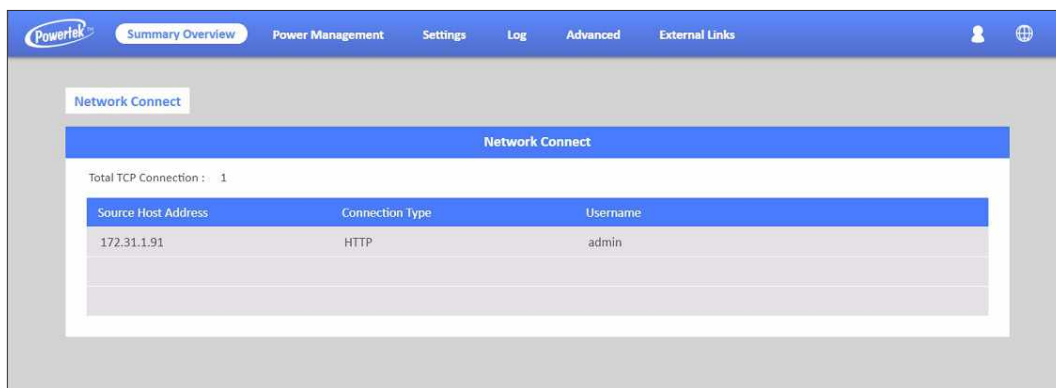

Source Host Address	Connection Type	Username
172.31.1.91	HTTP	admin

Using the Web Interface

Power Management-Inlet Configuration

This page lets the user configure Inlet load. You can set the condition of "Critical" and "Warning". (The value of "Critical" must be larger than "Warning").

When Inlet Power is over the condition you set, the light of status will become the corresponding colour.(Red means "Critical", Yellow means "Warning" and Green means "Normal") And you will receive the notification mail if you have set it in Email Notification.

The screenshot displays the Power Management web interface. The top navigation bar includes 'Summary Overview', 'Power Management' (selected), 'Setting', 'Log', 'Advanced', and 'External Links'. A user profile 'admin' and a 'Logout' button are visible in the top right.

The main content area is divided into two sections:

Phase Load Management

PDU A

Phase	Current(A)	Voltage(V)	Frequency (Hz)	Power Factor(%)	Power(W/VA) Active/Apparent	Reactive Power (var)	Status
1	0.00	0.0	0.00	0.0	0.0/0.0	0.0	Normal

Residual Current (mA) 29.1 **Critical**

Configuration

PDU A

	Over Load Alarm(W)	Load Balance Alarm(%)	Over Current Alarm (A)	Over Voltage Alarm (V)
Critical	3520	100	16.00	250.0
Warning	2200	50	13.00	245.0

Residual Current (mA)

Alarm Threshold: 20

Apply

Using the Web Interface

Power Management-Environment Monitoring

This page shows the status of EMD and lets users set the alarm configuration. You can set the "Alarm Condition" of "Critical" and "Warning". (The value of "Critical" must be larger than "Warning") It will follow the Email Notification rule you set to send out mails.

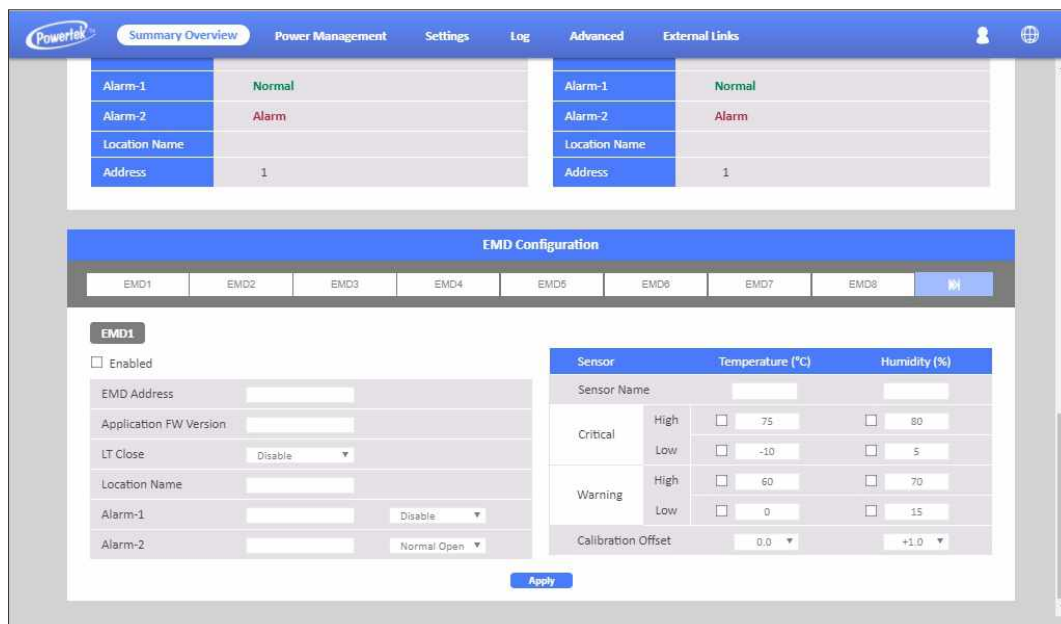
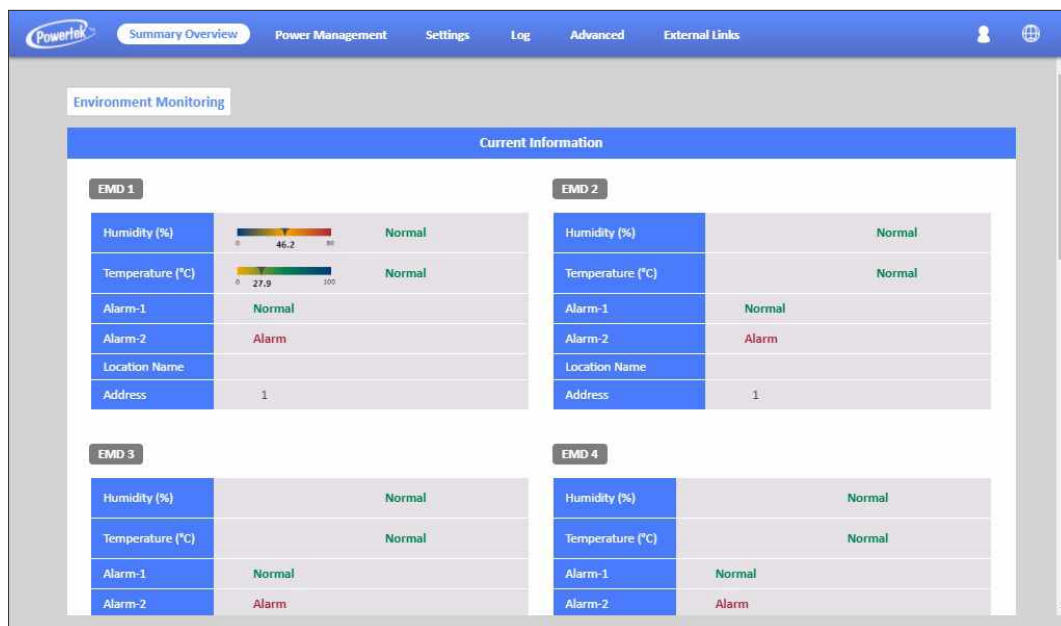

POWERTEK PDU supports 8 EMD sensors in cascade each one with 2 digital inputs of . you can set 2 alarms for each EMD sensor. There are 3 options(Normal Open/Normal Close/Disable) of the EMD sensor. If you set "Normal Open", the EMD sensor will become "Warning"(Yellow light) when closed.

Using the Web Interface

Network-TCP/IP

This page lets users enable DHCP and set an IP address manually.

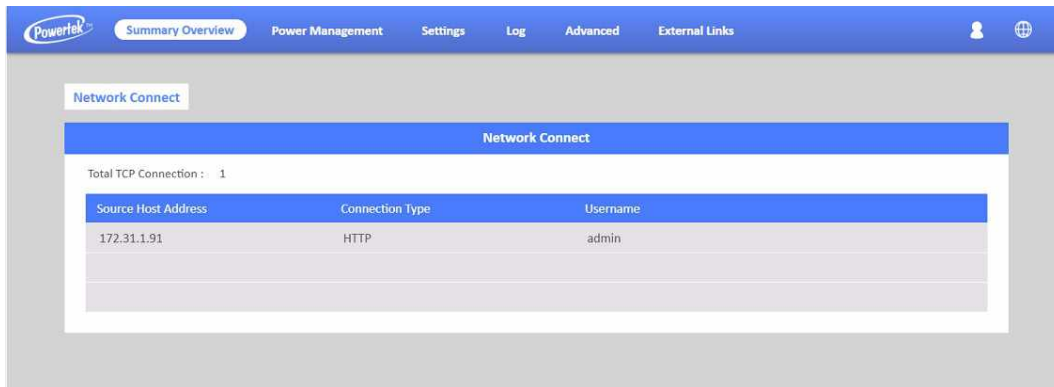

Network Management-Accessible IP Setting

This page lets users add/delete/modify accessible IP list.

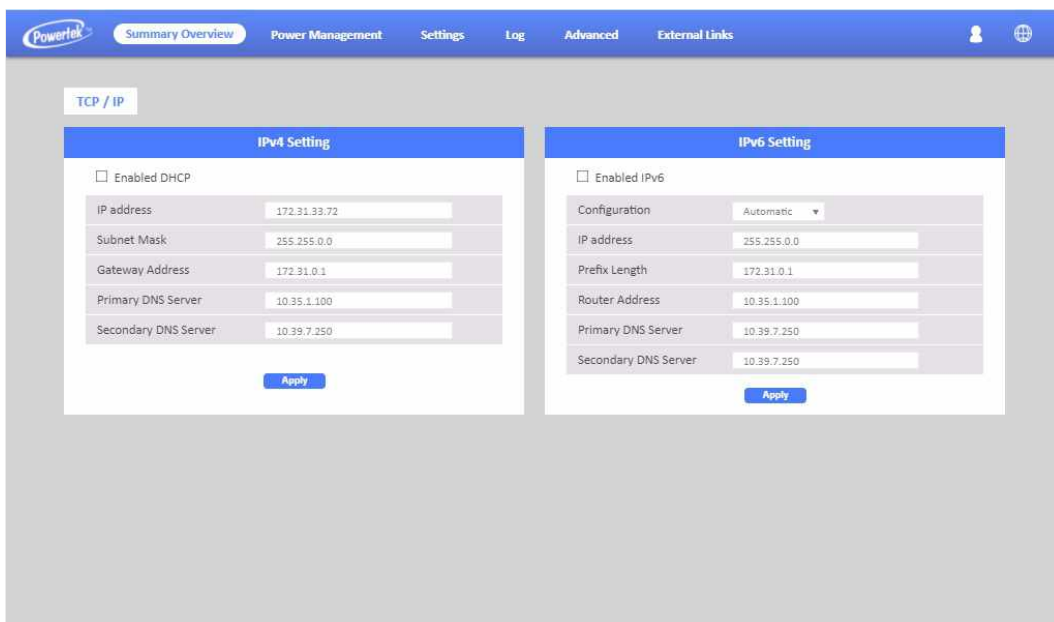

Using the Web Interface

Network Management-Security

This page lets users enable DHCP and set an IP address manually.

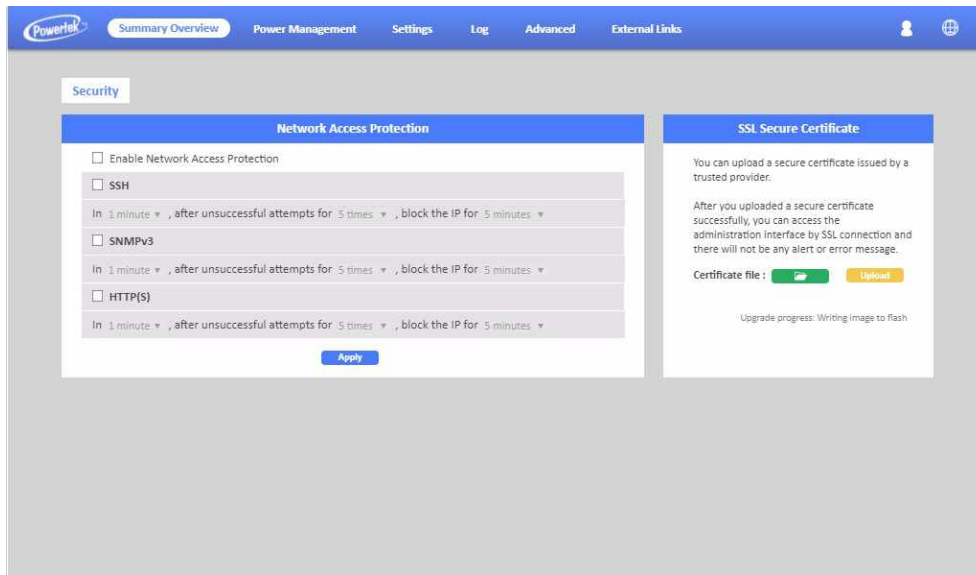

Network Management-Network Service

This page lets the user set SSH/SSL/Ping/RADIUS Setting. If a user wants to add Radius User(from Settings menu), they have to "Enable RADIUS" on this page first.

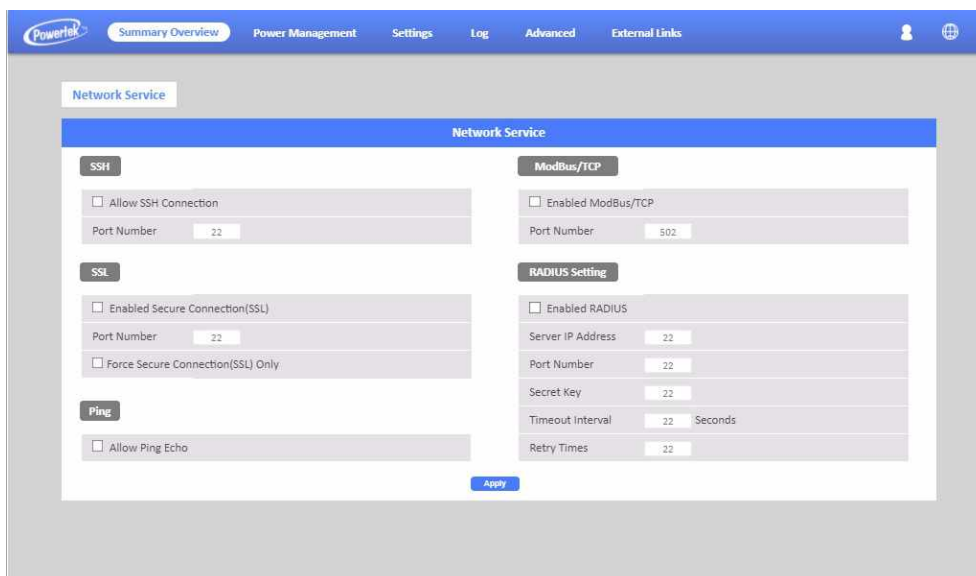

Using the Web Interface

Network Management-SNMP Segments

This page lets users set the SNMP Agent.

The screenshot displays the Powertek web interface. At the top, there is a navigation bar with the Powertek logo and several menu items: Summary Overview, Power Management, Settings, Log, Advanced, and External Links. The main content area is titled "SNMP Setting". It is divided into two sections: "SNMP Agent" and "SNMP Trap Setting".

The "SNMP Agent" section includes a checkbox for "Enable SNMP Service". Below this are four input fields: "Port Number" (containing "xxx"), "SNMP Version" (a dropdown menu set to "v1"), "Community Read" (containing "xxx"), and "Community Write" (containing "xxx"). An "Apply" button is located at the bottom of this section.

The "SNMP Trap Setting" section features a table with the following columns: "Receiver Address", "Event Level", "Trap Version", and "Description". The table currently contains three empty rows, each with a checkbox in the "Receiver Address" column. To the right of the table are three small icons: a left arrow, a right arrow, and a gear icon.

Network Management-SNMP Trap Segmenting

This page lets users add/delete/modify SNMP trap settings.

This screenshot shows a close-up of the "SNMP Trap Setting" section from the previous image. It displays a table with the following columns: "Receiver Address", "Event Level", "Trap Version", and "Description". The table has three rows, each with a checkbox in the "Receiver Address" column. To the right of the table are three small icons: a left arrow, a right arrow, and a gear icon.

Using the Web Interface

SiGns-General Segmenting

This page lets the user set General Settings.

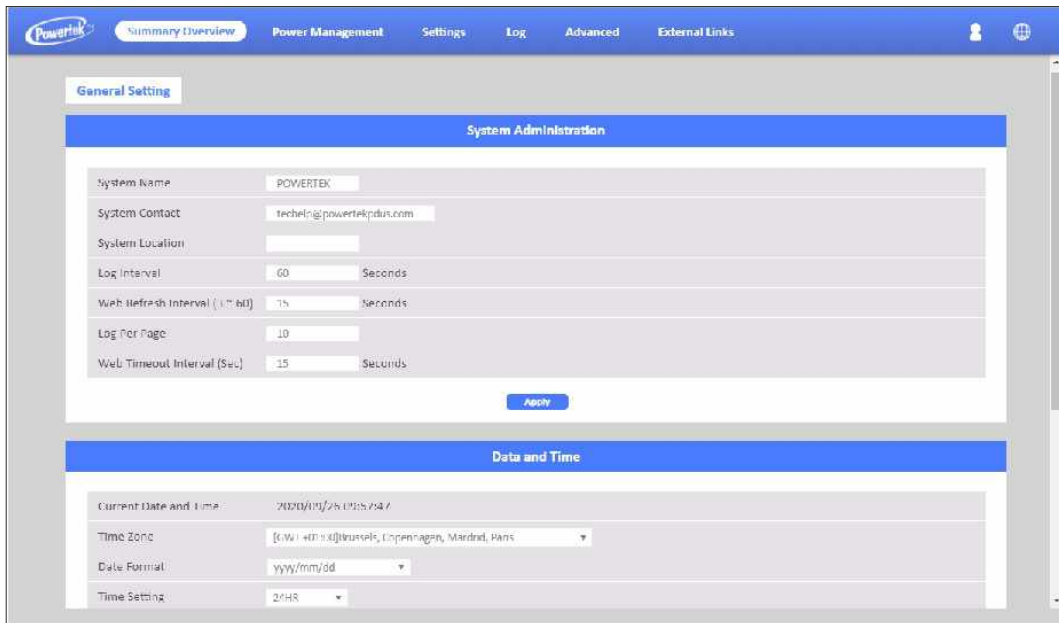

The screenshot displays the 'General Setting' page in the Powertek web interface. The page is divided into two main sections: 'System Administration' and 'Data and Time'. The 'System Administration' section contains the following fields:

Field	Value
System Name	POWERTEK
System Contact	tech@powertek.dk
System Location	
Log Interval	60 Seconds
Web Refresh Interval (UTC:00)	15 Seconds
Log Per Page	10
Web Timeout Interval (Sec)	15 Seconds

An 'Apply' button is located below the 'System Administration' section. The 'Data and Time' section contains the following fields:

Field	Value
Current Date and Time	2020/01/26 09:57:54
Time Zone	[GMT+01:00]Copenhagen, Copenhagen, Madrid, Paris
Date Format	yyyy/mm/dd
Time Setting	24HR

User management

This page lets the user enable new users and passwords.

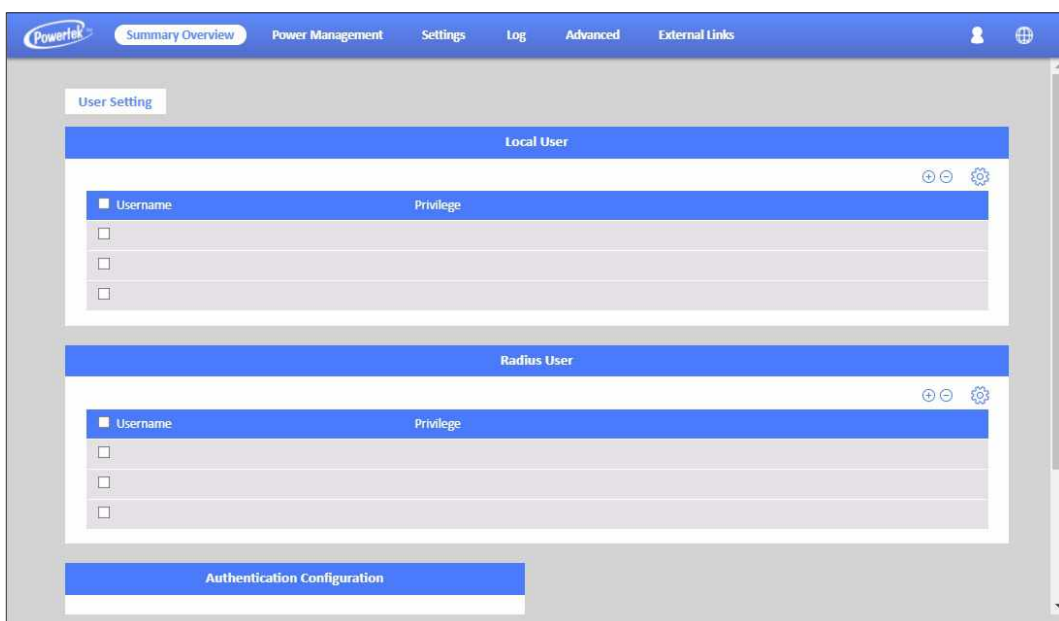

The screenshot displays the 'User Setting' page in the Powertek web interface. The page is divided into three main sections: 'Local User', 'Radius User', and 'Authentication Configuration'. The 'Local User' section contains a table with the following columns: 'Username' and 'Privilege'. The 'Radius User' section contains a table with the following columns: 'Username' and 'Privilege'. The 'Authentication Configuration' section is currently empty.

Section	Column 1	Column 2
Local User	Username	Privilege
Local User	<input type="checkbox"/>	
Local User	<input type="checkbox"/>	
Local User	<input type="checkbox"/>	
Radius User	Username	Privilege
Radius User	<input type="checkbox"/>	
Radius User	<input type="checkbox"/>	
Radius User	<input type="checkbox"/>	

Using the Web Interface

SiGns-Maintenance

This page lets the user set Reset/Upgrade/Reboot.

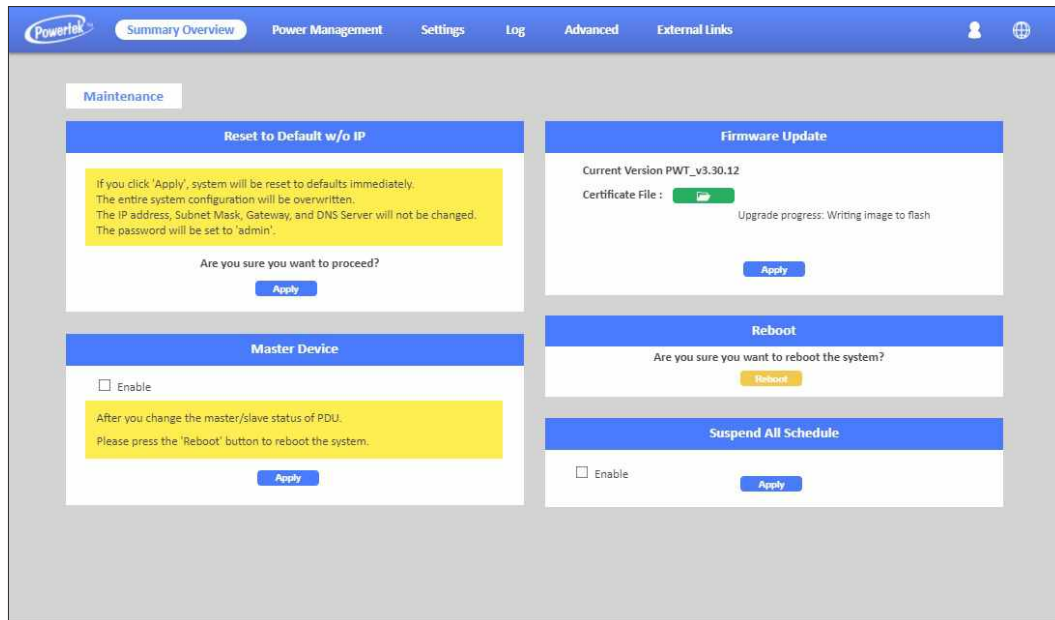

SeGments-Import/export

This page lets users import/export XML file to restore/download the configuration.

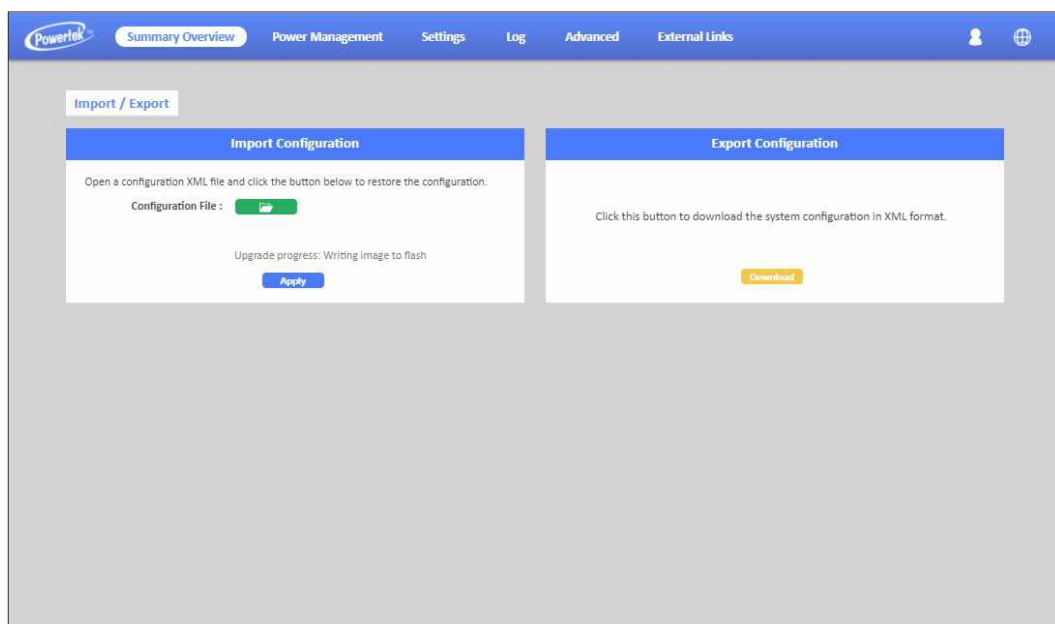

Using the Web Interface

SiGns-Radius User

This page lets power admin to Add/Delete/Modify Radius users.

You have to Enable RADIUS and set ready in the Network Service. Then you can add a Radius User and set outlet control for this user. The Grouping & Schedule function also supports radius users.

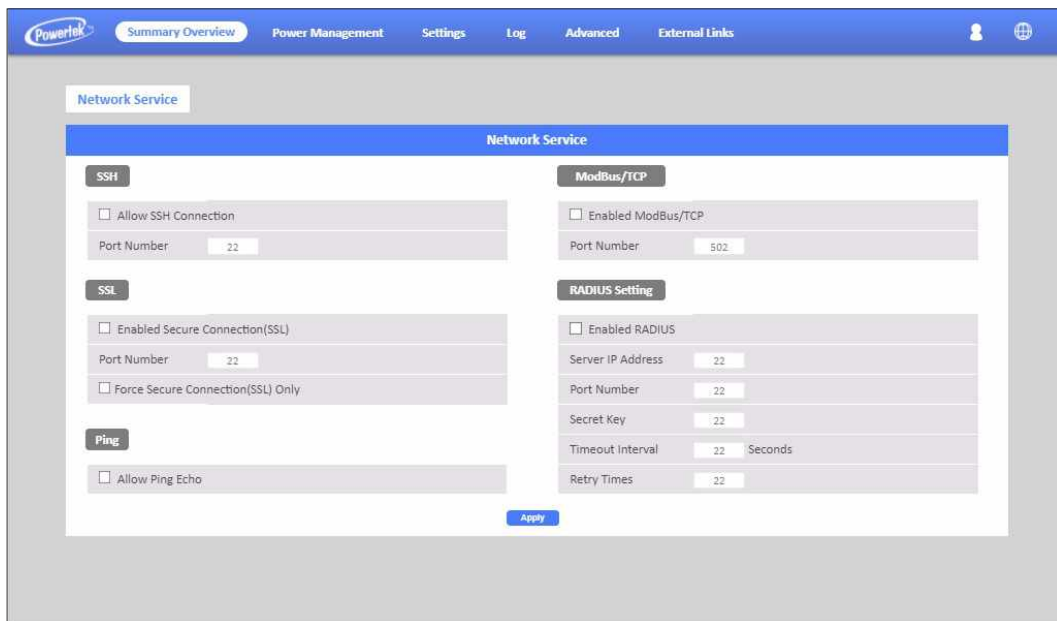

The screenshot displays the 'Network Service' configuration page in the Powertek web interface. The page is organized into several sections, each with a title bar and a list of settings:

- SSH:** Includes a checkbox for 'Allow SSH Connection' and a 'Port Number' input field set to 22.
- ModBus/TCP:** Includes a checkbox for 'Enabled ModBus/TCP' and a 'Port Number' input field set to 502.
- SSL:** Includes checkboxes for 'Enabled Secure Connection(SSL)' and 'Force Secure Connection(SSL) Only', and a 'Port Number' input field set to 22.
- Ping:** Includes a checkbox for 'Allow Ping Echo'.
- RADIUS Setting:** Includes a checkbox for 'Enabled RADIUS', and input fields for 'Server IP Address' (22), 'Port Number' (22), 'Secret Key' (22), 'Timeout Interval' (22 Seconds), and 'Retry Times' (22).

An 'Apply' button is located at the bottom center of the configuration area.

NOTE: If there are 2 users with the same name both existed in Local User & Radius User, Local user will become a priority in POWERTEK PDU.

Using the Web Interface

SeNGS-LOCAL User

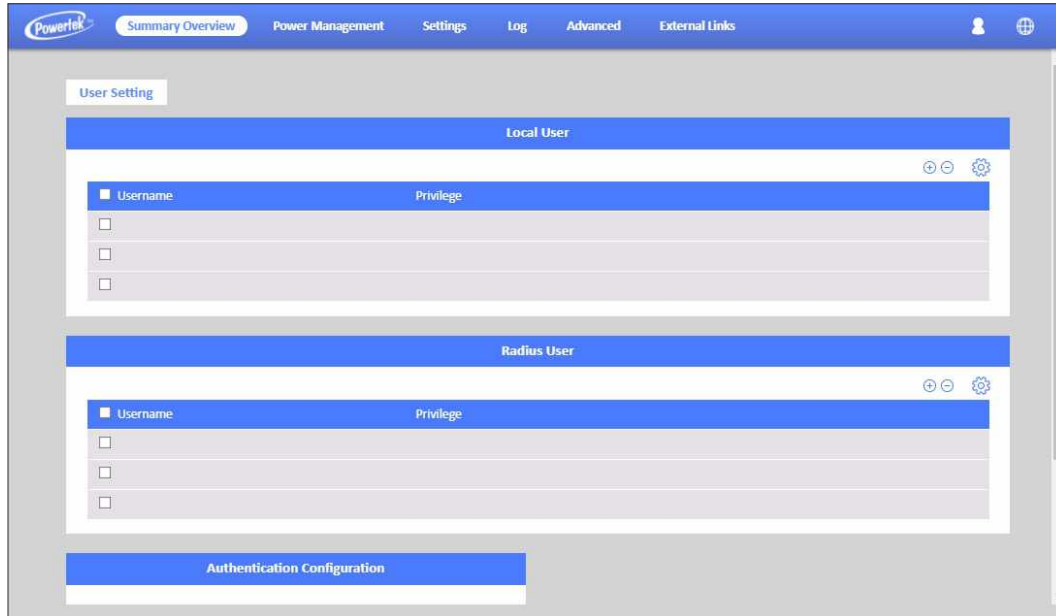

This page shows the user list and admin that can add/delete/modify it. The list can be up to 8 users. There are 4 kinds of privileges for the user account, the definition is as below:

Privilege	Definition
Power Admin	Users can manage all functions.
Admin	Admin users cannot manage [User Management], [Outlet Grouping], [FW Upgrade & Inlet/Outlet Upgrade], [Reset Default] function, and the others can still manage.
Supervision	Supervision users only manage [Power Monitoring] beside [Outlet Grouping], [Inlet/outlet upgrade] function.
User	Cannot manage any function. Read only.

Using the Web Interface

Log and Notification-System Log

This page shows the system log

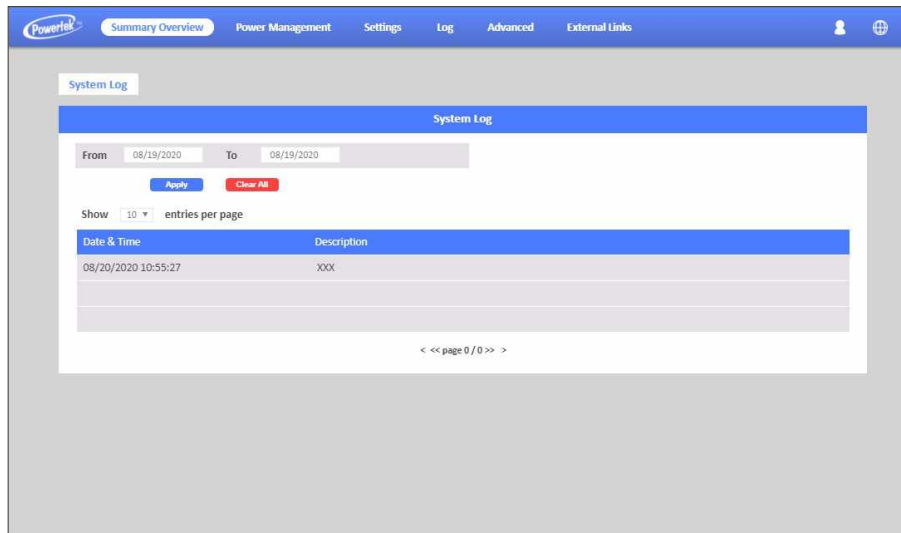

Log and Notification-Event Log

This page shows the warnings and alarms history log.

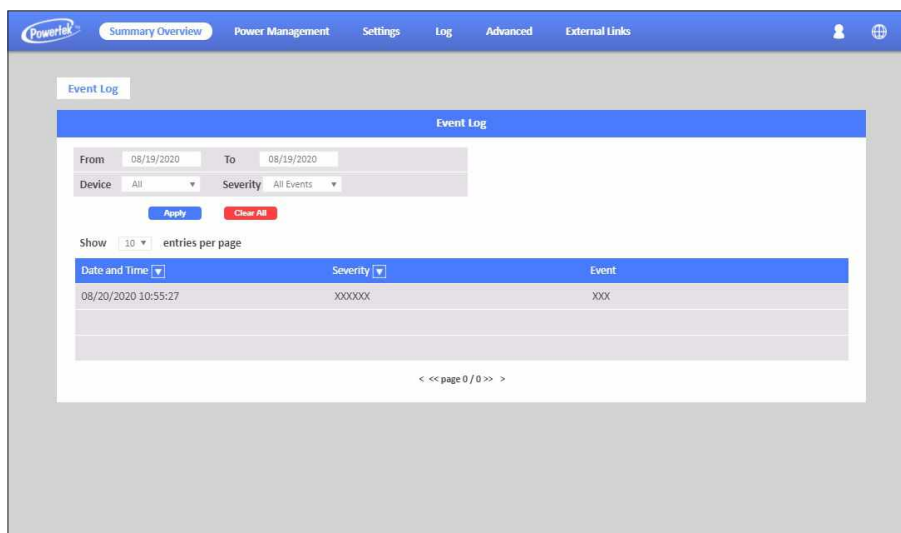

Using the Web Interface

SiGns-Configure SMTP Server

This page let user configure SMTP server.

SNMP Setting

SNMP Agent

Enable SNMP Service

Port Number: XXX

SNMP Version: v1

Community Read: XXX

Community Write: XXX

Apply

SNMP Trap Setting

Receiver Address	Event Level	Trap Version	Description
<input type="checkbox"/>			
<input type="checkbox"/>			
<input type="checkbox"/>			

SeGments-Email Notification Settings

This page lets the user set Email notification settings. Click "+" to set a new setting. Input "Receiver Address", select "Email Type"/"Event Level" and "Description", then click "Apply" to save settings. You can send a test mail to confirm the setting is correct or not through clicking "Send Test". After setting well, you will get a notification email when the event has been triggered.

Email Settings

Configure SMTP Server

SMTP Server: XXXX

Port Number: 25

Sender Email Address: XXXXX@XXX.XXX

Prefix: XXX

Enable SMTP Authentication

UserName: XXX

Password: *****

Apply

Email Notification Setting

Receiver Address	Email Type	Event Level	Description	
<input type="checkbox"/>	XXX.XXX.XXX	XXX	XXXX	X
<input type="checkbox"/>				
<input type="checkbox"/>				

Using the Web Interface

Log and Notification-Inlet History Log

This page shows the inlet history log. You can set the log interval in General Setting under the System Management.

Date and Time	Device Name	Pwr.W	Pwr.Max.W	Ph1 I.A	Ph2 I.A	Ph3 I.A	Ph1 I Max.A	Ph2 I Max.A	Ph3 I Max.A
08/20/2020 10:55:27	PDU A	0.0	0.0	0.00	0.00	0.00	112.3	99.9	59.81

Log and Notification-Environment History Log

This page shows the environment history log. You can set the log interval in General Setting under System Management.

Date and Time	Device	Temp.C	Hum.%RH
08/20/2020 10:55:27	XXX	XXX	XXX



More information at: www.powertekpdus.com
© Powertek Industries Ltd. All Rights Reserved

